



Shaft Styles

4" OD Fluted
.125 Wall



4"OD Smooth
.125 Wall



5" OD Fluted
.156 Wall



5" OD Smooth
.125 Wall

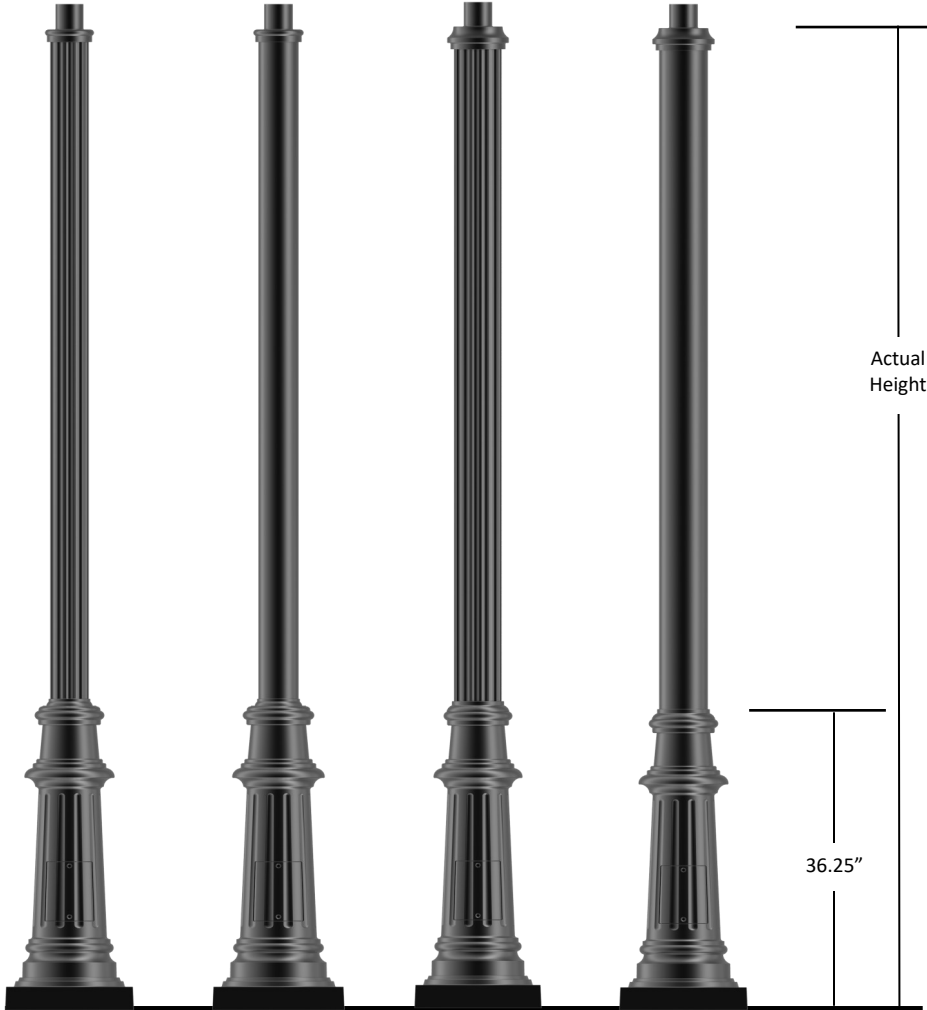

FEATURES

- Strong, lightweight and easy to install
- Extruded aluminum shaft welded to a decorative cast aluminum base
- 3" OD x 3" tall tenon included for luminaire mounting
- Access door for wiring secured with stainless steel screws
- Ground lug included inside base
- Durable powder coat finish
- 1/2" x 18" Anchor Bolts & Template included

MATERIALS

- Base - Cast Aluminum (A356)
- Shaft - Extruded Aluminum (6061-T6)
- Tenon - Cast Aluminum (A356)
- Anchor Bolts - Hot Dipped Galvanized
- Hardware—Stainless Steel

ACCESSORIES

- **GFCI** Box with weatherproof WIUC (Additional accessories below ordered separately) (See Accessories Page for ordering guide)
- Clamp on banner arms
- Direct bury extension
- Clamp on flag pole holder

ANCHORAGE

- 1/2" x 18" x 3" Hot-dipped galvanized steel L-type anchor bolts.
- (4) Bolts with (2) nuts, (2) washers per bolt included

GP33-xx	GP34-xx	GP35-xx	GP36-xx	Actual Height
GP33-08	GP34-08	GP35-08	GP36-08	7' 8"
GP33-10	GP34-10	GP35-10	GP36-10	9' 8"
GP33-12	GP34-12	GP35-12	GP36-12	11' 8"
GP33-14	GP34-14	GP35-14	GP36-14	13' 8"



Pole Details

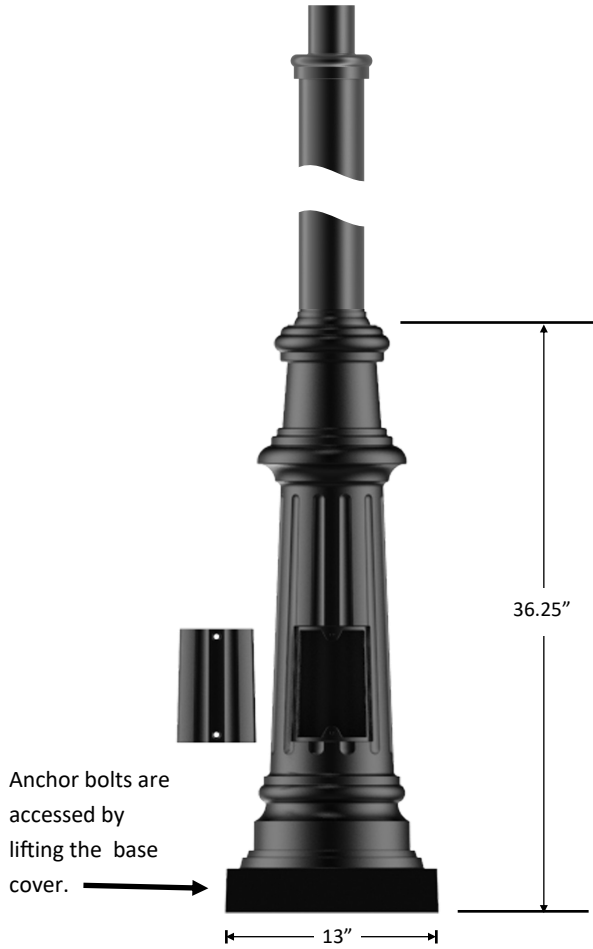

Finish

The post will be finished with an electrostatically applied polyester powder coat suitable for exterior use. The poles are pretreated using industry standard environmentally responsible processes for a long lasting and durable finish.

Standard Finishes

- BK** - Black (Gloss)
- BT** - Black (Textured)
- SB** - Statuary Bronze
- GN** - Green

Premium Finishes

- WH** - White (Gloss)
- CV** - Copper Vein
- GV** - Green Vein
- CF** - Custom Finishes

Tenons

- 3" OD x 3" Tall Tenon Standard
- TNS54** - 4" OD x 3" Tall Tenon slip fits over 5" smooth shaft
- TNF54** - 4" OD x 3" Tall Tenon slip fits over 5" fluted shaft
- LT** - Less Tenon
- Other tenons available upon request*
- Check fixture and/or arm spec sheet for tenon requirements*

Accessories

GFCI - Provision for Ground Fault Circuit Interrupter outlet with NEC required wet location while in use type cover (WIUC). The cover is made of die cast aluminum and will be painted to match.

GFCI Orientation is stated as degrees from access door and **GFCI Placement** on shaft must be specified in ordering guide below.

- TOP** - placement will be 6" from top of pole.
- BOT** - placement will be 6" above the base.

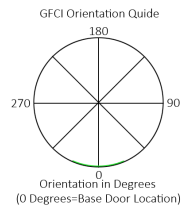

(Additional accessories below ordered separately)
(See Accessories Page for ordering guide)

Flag Pole Holder

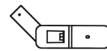

Direct Bury Extension

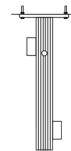

Single and Double Sided Field Rotatable Banner Arm

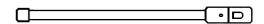

Anchor Bolt Details

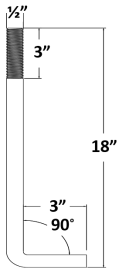

- (4) 1/2" Galvanized Steel L-Type Anchor Bolts
- (8) 1/2" Galvanized Steel Hex Nuts
- (8) 1/2" Galvanized Steel Flat Washers
- (8) 3/4" Galvanized Steel Flat Washers

Ordering Guide

	Pole/Shaft Style	Height	Tenon	Accessory	GFCI Orientation	GFCI Placement	Finish
EXAMPLE	GP34	14	/ Leave blank for standard /	GFCI	BOT	180	BT
	GP33	08	TNS54	GFCI	TOP	0	BK
	GP34	10	TNF54		BOT	90	BT
	GP35	12	LT			180	SB
	GP36	14				270	GN
							Premium Finishes WH, CV, GV, CF
	Required			Optional			Choose Finish