

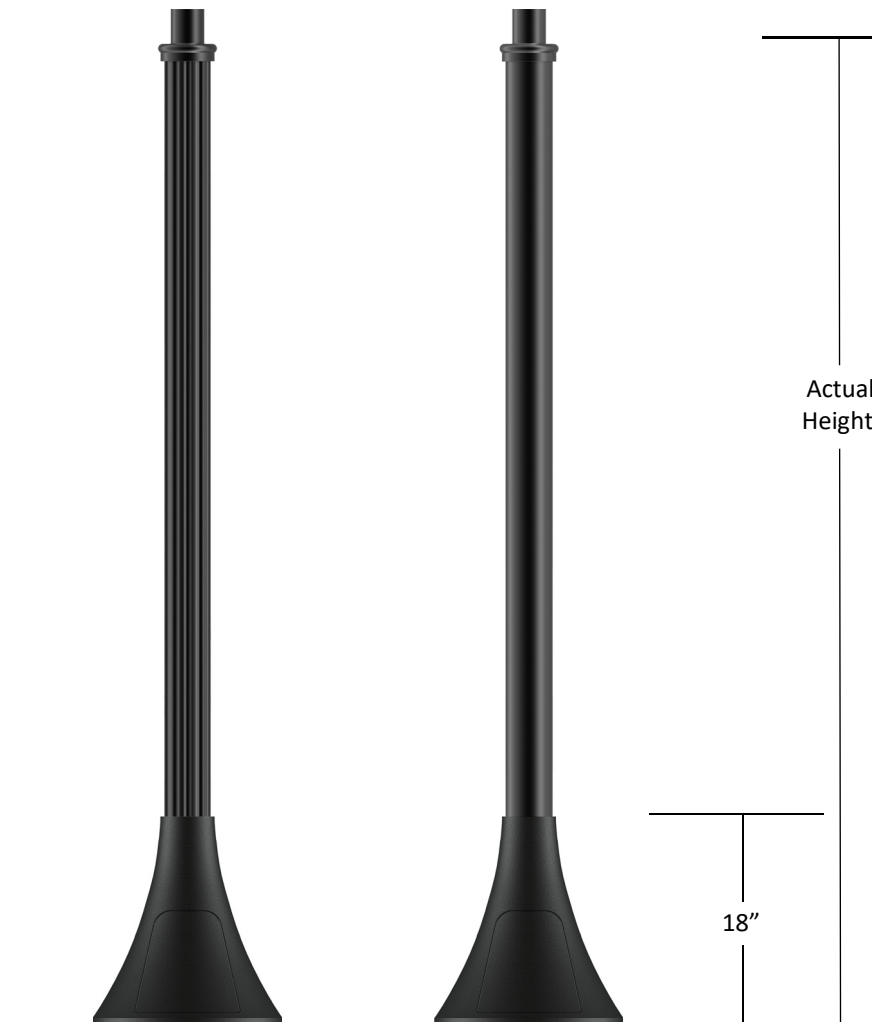

4" OD Fluted
.125 Wall



4" OD Smooth
.125 Wall



FEATURES

- Extruded aluminum shaft welded to a cast aluminum base
- 3" OD x 3" tall tenon included for luminaire mounting
- Access door for wiring secured with stainless steel screws
- Ground lug included inside base
- Durable powder coat finish
- 1/2" x 18" Anchor Bolts & Template included

MATERIALS

- Base - Cast Aluminum (A356)
- Shaft - Extruded Aluminum (6061-T6)
- Tenon - Cast Aluminum (A356)
- Anchor Bolts - Hot Dipped Galvanized
- Hardware - Stainless Steel

ACCESSORIES

- **GFCI** Box with weatherproof WIUC And TR WR Rated 20A GFCI Receptacle (Additional accessories below ordered separately) (See Accessories Page for ordering guide)
- Clamp on banner arms
- Direct bury extension
- Clamp on flag pole holder

ANCHORAGE

- 1/2" x 18" x 3" Hot-dipped galvanized steel L-type anchor bolts.
- (4) Bolts with (2) nuts, (2) washers per bolt included

FINISH

The post will be finished with an electrostatically applied polyester powder coat suitable for exterior use. The poles are pretreated using industry standard environmentally responsible processes for a long lasting and durable finish.

Standard Finishes

- BK** - Black (Gloss)
- BT** - Black (Textured)
- SB** - Statuary Bronze
- GN** - Green

Premium Finishes

- WH** - White (Gloss)
- CV** - Copper Vein
- GV** - Green Vein
- CF** - Custom Finishes

GP73-xx	GP74-xx	Actual Height
GP73-08	GP74-08	8' 2"
GP73-10	GP74-10	10' 2"
GP73-12	GP74-12	12' 2"
GP73-14	GP74-14	14' 2"



POLE DETAILS

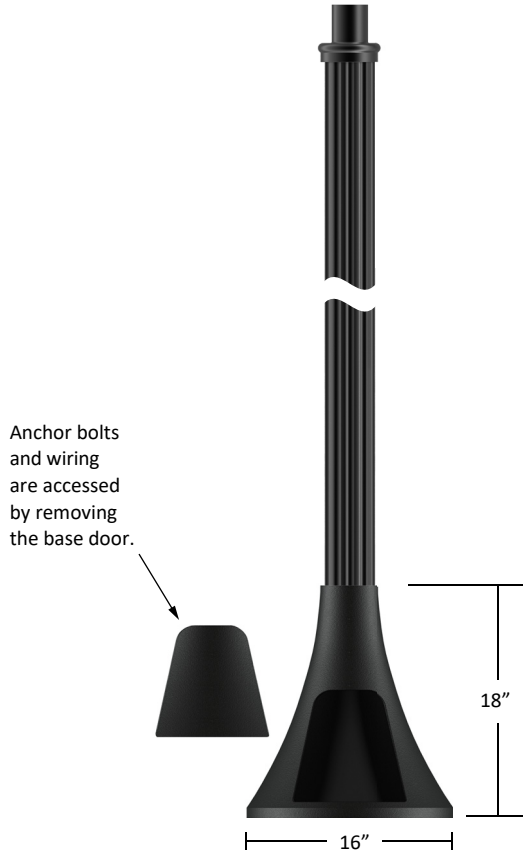

TENONS

3" OD x 3" Tall Tenon Standard
 LT - Less Tenon
 Other tenons available upon request
 Check fixture and/or arm spec sheet for tenon requirements

ACCESSORIES

GFCI - Ground Fault Circuit Interrupter Box with NEC required wet location While-In-Use-Cover (WIUC) and TR WR rated 20A GFCI Receptacle. The cover is made of die cast aluminum and will be painted to match.
GFCI Orientation is stated as degrees from access door and **GFCI Placement** on shaft must be specified in ordering guide below.
TOP - placement will be 6" from top of pole.
BOT - placement will be 6" above the base.

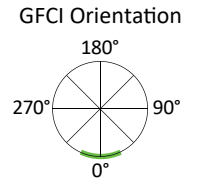

(Additional accessories below ordered separately)
 (See Accessories Page for ordering guide)

Flag Pole Holder

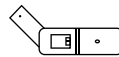

Direct Bury Extension

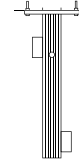

Single and Double Sided Field Rotatable Banner Arm

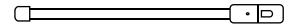

BOLT CIRCLE DETAILS

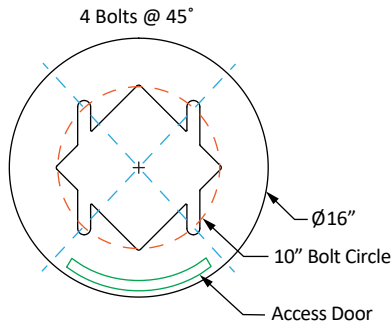

ANCHOR BOLT DETAILS

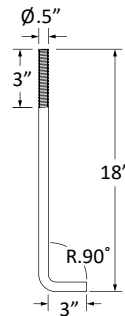

- (4) 1/2" Galvanized Steel L-Type Anchor Bolts
- (8) 1/2" Galvanized Steel Hex Nuts
- (8) 1/2" Galvanized Steel Flat Washers
- (8) 3/4" Galvanized Steel Flat Washers

ORDERING GUIDE

	Pole/Shaft Style	Height	Tenon	Accessory	GFCI Orientation	GFCI Placement	Finish
EXAMPLE	GP73	14	Leave blank if standard	GFCI	BOT	180	BT
	GP73	08	LT	GFCI	TOP	0	Premium Finishes WH, CV, GV, CF
	GP74	10			BOT	90	
		12				180	
		14				270	
	Required		Optional			Required	